

Features and Benefits

- 4.5V to 24V Operation
- -40°C to 150°C Superior temperature operation
- Bipolar technology
- Open-collector 25 mA output
- Reverse battery protection
- Small Size SOT23 3L or SIP 3L
- Solid-state reliability
- Resistant to physical stress
- Activate with small, commercially available Permanent magnets

Application Examples

- Automotive, Consumer and Industrial
- Solid-state switch
- Brushless DC motor commutation
- Speed detection
- Linear position detection
- Angular position detection
- Proximity detection

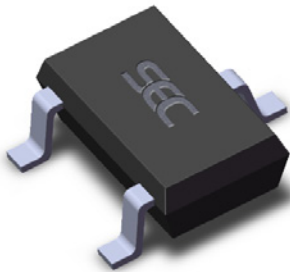

3 pin SOT23 (suffix SO)

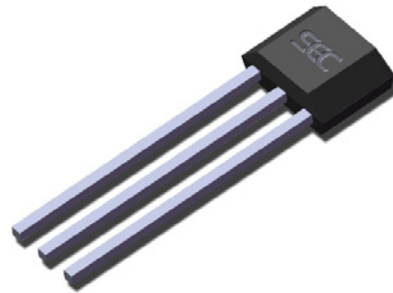

3 pin SIP (suffix UA)

Functional Block Diagram

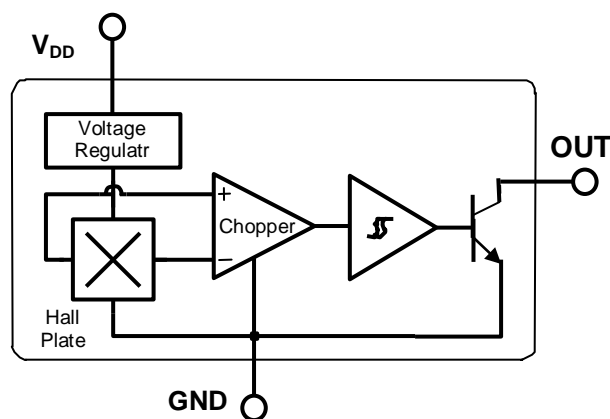

SIP Package	SOT Package
Pin 1 – V _{DD}	Pin 1 – V _{DD}
Pin 2 – GND	Pin 2 – OUT
Pin 3 – OUT	Pin 3 – GND

General Description

The SS1034 is a unipolar Hall-effect sensor IC fabricated from bipolar technology. The device integrates a voltage regulator, reverse battery protection diode, Hall sensor with dynamic offset cancellation system, temperature compensation circuitry, small signal amplifier, Schmitt trigger and an open-collector output to sink up to 25 mA. With suitable output pull up, they can be used with bipolar or CMOS logic circuits.

These Hall-effect switches are monolithic integrated circuits with tighter magnetic specifications, designed to operate continuously over extended tem-

peratures to +150°C, and are more stable with both temperature and supply voltage changes. The unipolar switching characteristic makes these devices ideal for use with a simple bar or rod magnet.

Thanks to its wide operating voltage range and extended choice of temperature range, it is quite suitable for use in automotive, industrial and consumer applications.

The device is delivered in a Small Outline Transistor (SOT) or in a Plastic Single In Line (SIP 3L flat). Both 3-lead packages are RoHS compliant.

Glossary of Terms

MilliTesla (mT), Gauss	Units of magnetic flux density: 1mT = 10 Gauss
RoHS	Restriction of Hazardous Substances
Operating Point (B_{OP})	Magnetic flux density applied on the branded side of the package which turns the output driver ON ($V_{OUT} = V_{DSon}$)
Release Point (BRP)	Magnetic flux density applied on the branded side of the package which turns the output driver OFF ($V_{OUT} = \text{high}$)

Pin Definitions and Descriptions

SOT Pin №	SIP Pin №	Name	Type	Function
1	1	V _{DD}	Supply	Supply Voltage pin
2	3	OUT	Output	Open Drain Output pin
3	2	GND	Ground	Ground pin

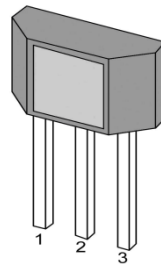
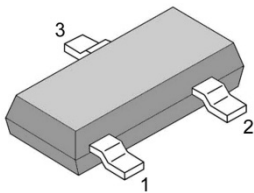
Absolute Maximum Ratings

Parameter	Symbol	Value	Units
Supply Voltage	V _{DD}	28	V
Supply Current	I _{DD}	50	mA
Output Voltage	V _{OUT}	28	V
Output Current	I _{OUT}	50	mA
Storage Temperature Range	T _S	-65 to 170	°C

Operating Temperature Range	Symbol	Value	Units
Temperature Suffix "E"	T _A	-40 to 85	°C
Temperature Suffix "K"	T _A	-40 to 125	°C
Temperature Suffix "L"	T _A	-40 to 150	°C

Exceeding the absolute maximum ratings may cause permanent damage. Exposure to absolute-maximum- rated conditions for extended periods may affect device reliability

General Electrical Specifications

DC Operating Parameters $T_A = 25^\circ\text{C}$, $V_{DD} = 4.5\text{V}$ to 24V (unless otherwise specified)

Parameter	Symbol	Test Conditions	Min	Typ	Max	Units
Supply Voltage	V_{DD}	Operating	4.5		24	V
Supply Current	I_{DD}	$B < B_{RP}$	4	5	7	mA
Output Saturation Voltage	V_{DSon}	$I_{OUT} = 20\text{mA}$, $B > B_{OP}$		0.3	0.5	V
Output Leakage Current	I_{OFF}	$B < B_{RP}$ $V_{OUT} = 24\text{V}$		0.1	10	μA
Output Rise Time	t_r	$R_L = 820\Omega$, $C_L = 20\text{pF}$		0.04	2.0	μs
Output Fall Time	t_f	$R_L = 820\Omega$, $C_L = 20\text{pF}$		0.18	2.0	μs

Magnetic Specifications

DC Operating Parameters $V_{DD} = 4.5\text{V}$ to 24V (unless otherwise specified)

Package	Parameter	Symbol	Test Conditions	Min	Typ	Max	Units
UA	Operating Point	B_{OP}	$T_a = 25^\circ\text{C}$, $V_{DD} = 12\text{V DC}$	70	85	100	G
	Release Point	B_{RP}		20	40	70	G
	Hysteresis	B_{HYST}			45		G
SO	Operating Point	B_{OP}	$T_a = 25^\circ\text{C}$, $V_{DD} = 12\text{V DC}$	-100	-85	-70	G
	Release Point	B_{RP}		-70	-40	-20	G
	Hysteresis	B_{HYST}			45		G

Output Behavior versus Magnetic Pole

DC Operating Parameters $T_A = -40^\circ\text{C}$ to 150°C , $V_{DD} = 4.5\text{V}$ to 24V (unless otherwise specified)

Test Conditions (UA)	Test Conditions (SO)	OUT
$B < B_{RP}$	$B > B_{RP}$	High
$B > B_{OP}$	$B < B_{OP}$	Low

The SOT-23 device is reversed from the UA package. The SOT-23 output transistor will be turned on (drops low) in the presence of a sufficiently strong North pole magnetic field applied to the marked face.

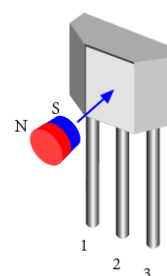
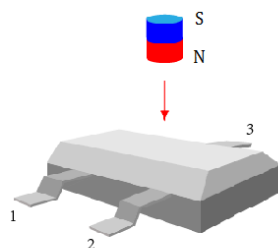

Electrical parameters Figure

Magnetic parameter vs. T_a

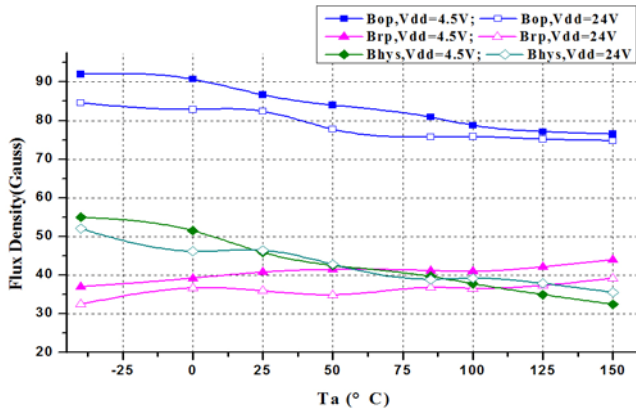

T_a Magnetic parameter vs. V_{DD}

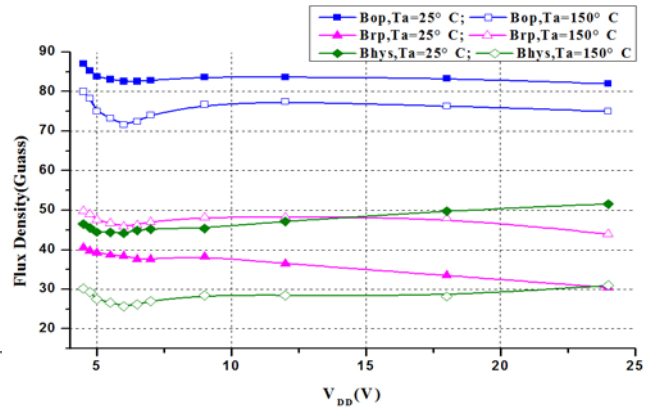

V_{DSON} vs. T_a

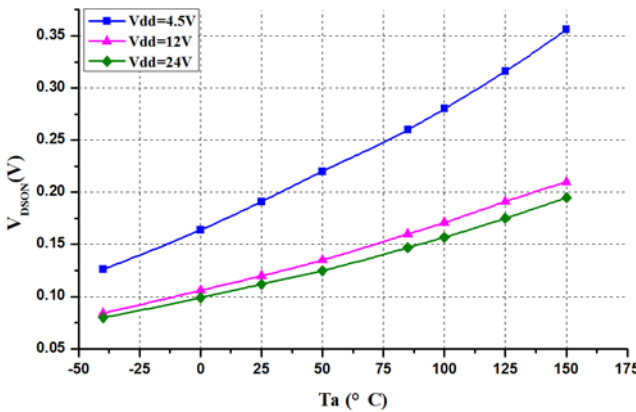

V_{DSON} vs. V_{DD}

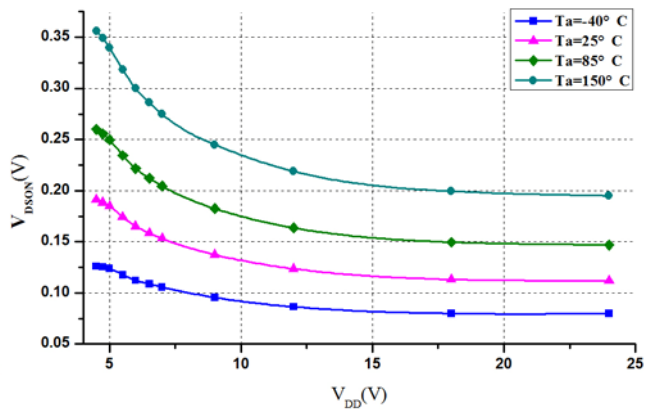

I_{DD} vs. T_a

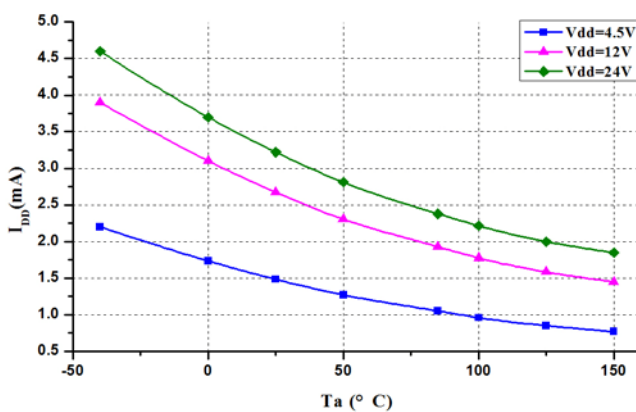

I_{DD} vs. V_{DD}

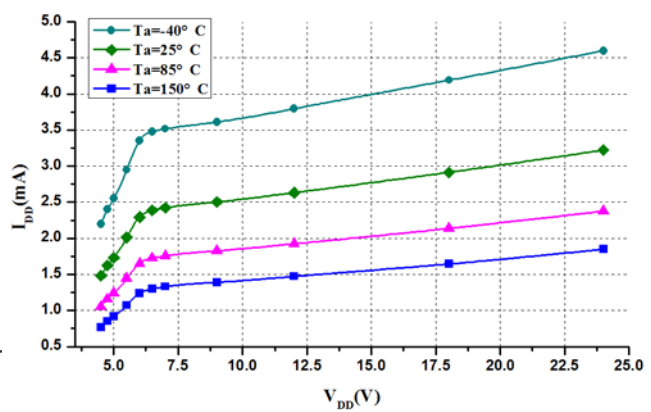

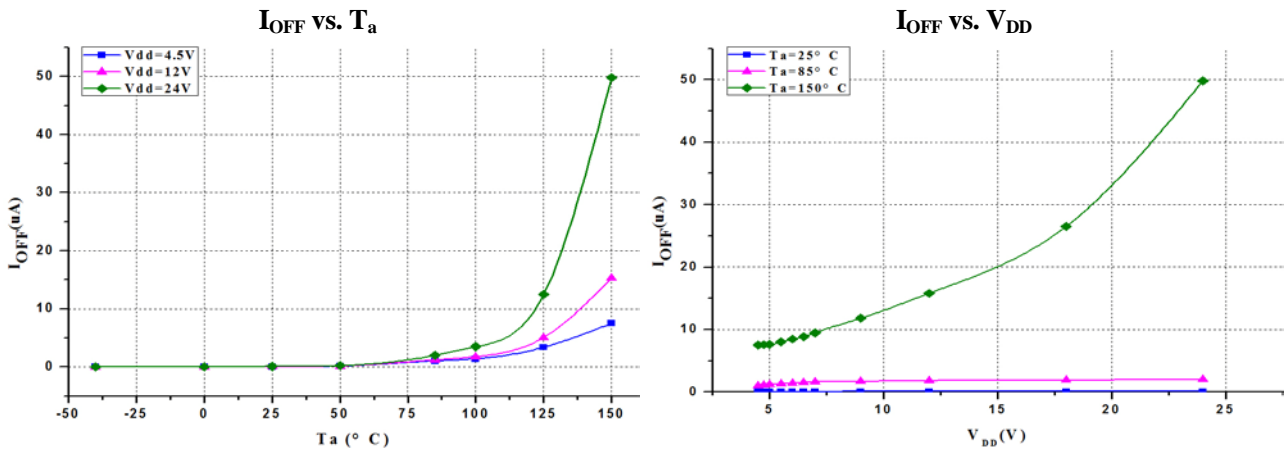

Application Information

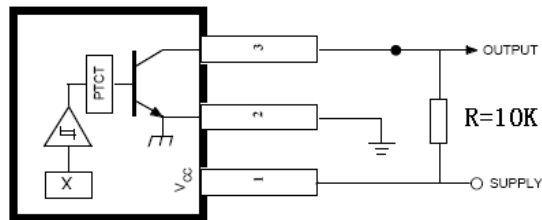

Package Information

Package UA, 3-Pin SIP:

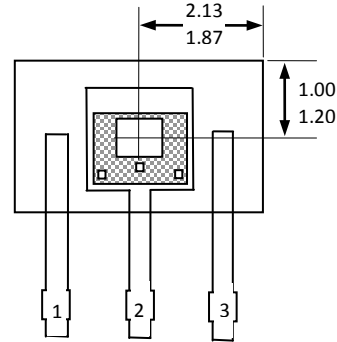
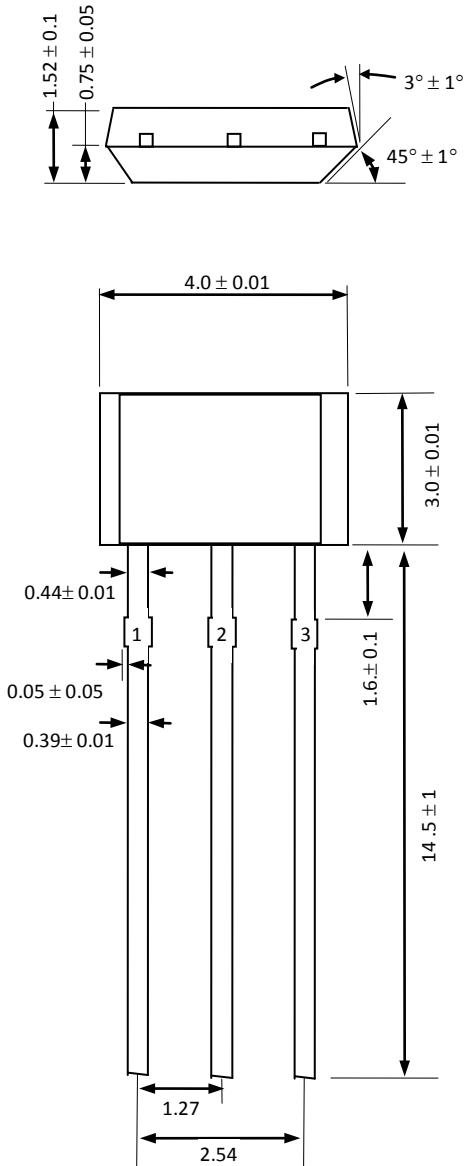

Sensor Location

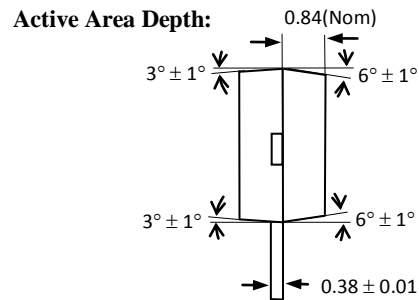

Notes:

- 1). Controlling dimension : mm ;
- 2). Leads must be free of flash and plating voids ;
- 3). Do not bend leads within 1 mm of lead to package interface ;
- 4). PINOUT: Pin 1 V_{DD}
Pin 2 GND
Pin 3 Output

Package SO, 3-Pin SOT-23:

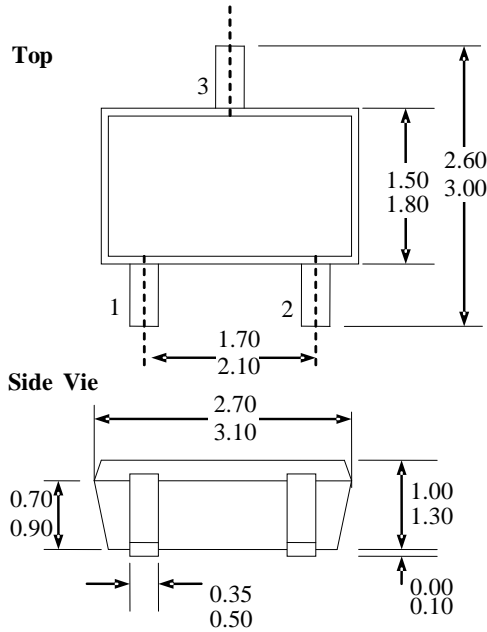

Notes

- 1). PINOUT: Pin 1 V_{DD}
Pin 2 Output
Pin 3 GND
- 2). All dimensions are in millimeters;

Ordering Information

Part No.	Pb-free	Temperature Code	Package Code	Packing
SS1034ESOT	YES	-40°C to 85°C	SOT-23	7-in. reel, 3000 pieces/ reel
SS1034EUA	YES	-40°C to 85°C	TO-92	Bulk, 1000 pieces/ bag
SS1034KSOT	YES	-40°C to 125°C	SOT-23	7-in. reel, 3000 pieces/ reel
SS1034KUA	YES	-40°C to 125°C	TO-92	Bulk, 1000 pieces/ bag
SS1034LSOT	YES	-40°C to 150°C	SOT-23	7-in. reel, 3000 pieces/ reel
SS1034LUA	YES	-40°C to 150°C	TO-92	Bulk, 1000 pieces/ bag