

### Features

- Solid-State Reliability much better than reed switch
- Omnipolar, output switches with absolute value of North or South pole from magnet
- Wide operating voltage range from 3.5V to 24V
- High sensitivity for direct reed switch replacement applications

### Applications

- Solid state switch
- Speed detection
- Interrupter
- Magnet proximity sensor for reed switch replacement

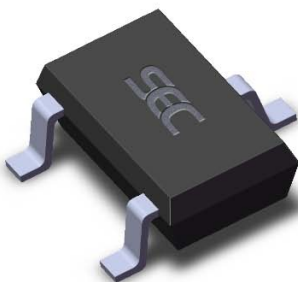

3 pin SOT23 (suffix SO)

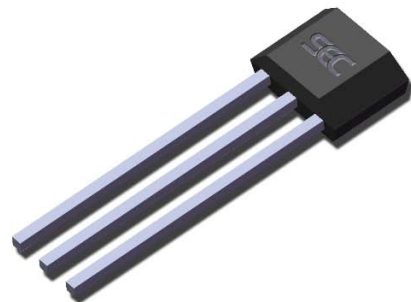

3 pin SIP (suffix UA)

### General Description

The SS275 Omnipolar Hall effect sensor IC is fabricated from mixed signal CMOS technology .It incorporates advanced chopper-stabilization techniques to provide accurate and stable magnetic switch points. The output transistor of the SS275 will be latched on ( $B_{OP}$ ) in the presence of a sufficiently strong South or North magnetic field facing the marked side of the package. The output will be latched off ( $B_{RP}$ ) in the absence of a magnetic field.

The chopper stabilized amplifier uses switched capacitor techniques to eliminate the amplifier offset voltage, which, in bipolar devices, is a major source of temperature sensitive drift. CMOS makes this advanced technique possible. The CMOS chip is also much smaller than a bipolar chip, allowing very sophisticated circuitry to be placed in less space. The small chip size also contributes to lower physical stress and less power consumption.

### Functional Block Diagram

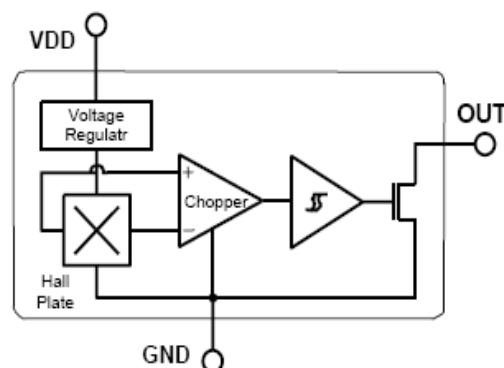

### Glossary of Terms

- MilliTesla (mT), Gauss    Units of magnetic flux density: 1mT = 10 Gauss
- RoHS                            Restriction of Hazardous Substances
- ESD                              Electro-Static Discharge
- Operating Point ( $B_{OP}$ )    Magnetic flux density applied on the branded side of the package which turns the output driver ON ( $V_{OUT} = V_{DSon}$ )
- Release Point ( $B_{RP}$ )        Magnetic flux density applied on the branded side of the package which turns the output driver OFF ( $V_{OUT} = \text{high}$ )

### Pin Definitions and Descriptions

SOT Pin №	SIP Pin №	Name	Type	Function
1	1	$V_{DD}$	Supply	Supply Voltage pin
2	3	OUT	Output	Open Drain Output pin
3	2	GND	Ground	Ground pin

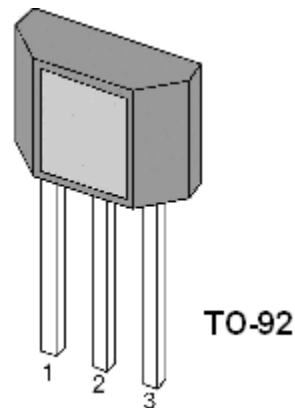
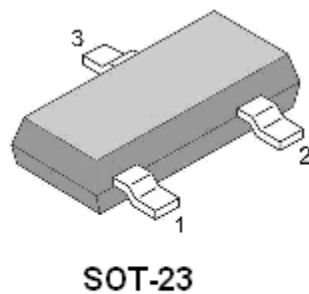

### Absolute Maximum Ratings

Parameter	Symbol	Value	Units
Supply Voltage(operating)	$V_{DD}$	28	V
Supply Current	$I_{DD}$	5	mA
Output Voltage	$V_{OUT}$	28	V
Output Current	$I_{OUT}$	10	mA
Operating Temperature Range	$T_A$	-40 to 150	°C
Storage Temperature Rang	$T_S$	-50 to 165	°C
ESD Sensitivity	-	4000	V

Exceeding the absolute maximum ratings may cause permanent damage. Exposure to absolute-maximum rated conditions for extended periods may affect device reliability.

## DC Electrical Characteristics

DC Operating Parameters:  $T_A = 25^\circ\text{C}$ ,  $V_{DD}=5\text{V}$ .

Parameter	Symbol	Test Conditions	Min	Typ	Max	Units
Operating voltage	$V_{DD}$	Operating	3.5		24	V
Supply current	$I_{DD}$	$B < B_{RP}$			5	mA
Output Saturation Voltage	$V_{DSon}$	$I_{OUT} = 20\text{mA}$ , $B > B_{OP}$			0.5	V
Output Leakage Current	$I_{OFF}$	$B < B_{RP}$ $V_{OUT} = 24\text{V}$		1	10	$\mu\text{A}$
Output Rise Time	$t_r$	$R_L = 1\text{k}\Omega$ , $C_L = 20\text{pF}$		0.25		$\mu\text{s}$
Output Fall Time	$t_f$	$R_L = 1\text{k}\Omega$ , $C_L = 20\text{pF}$		0.25		$\mu\text{s}$
Maximum Switching Frequency	FSW	---		10		KHz
Package Thermal Resistance	$R_{TH}$	Single layer (1S) Jeduc board		301		$^\circ\text{C/W}$

Operating Parameters:  $T_A = 25^\circ\text{C}$ ,  $V_{DD}=5\text{VDC}$ .

PARAMETER	Symbol	Min	Type	Max	Units
Operating Point	Bop	-	+/-35	+/-60	Gs
Release Point	Brp	+/-10	+/-20	-	Gs
Hysteresis	Bhys	-	15	-	Gs

## ESD Protection

Human Body Model (HBM) tests according to: Mil. Std. 883F method 3015.7

Parameter	Symbol	Limit Values		Unit	Notes
		Min	Max		
ESD Voltage	$V_{ESD}$	$\pm 2$	$\pm 4$	kV	

## ESD Precautions

Electronic semiconductor products are sensitive to Electro Static Discharge (ESD). Always observe Electro Static Discharge control procedures whenever handling semiconductor products.

### Installation Comments

Consider temperature coefficients of Hall IC and magnetics , as well as air gap and life time variations. Observe temperature limits during wave soldering. Typical IR solder-reflow profile:

- No Rapid Heating and Cooling.
- Recommended Preheating for max. 2minutes at 150°C
- Recommended Reflowing for max. 5seconds at 240°C

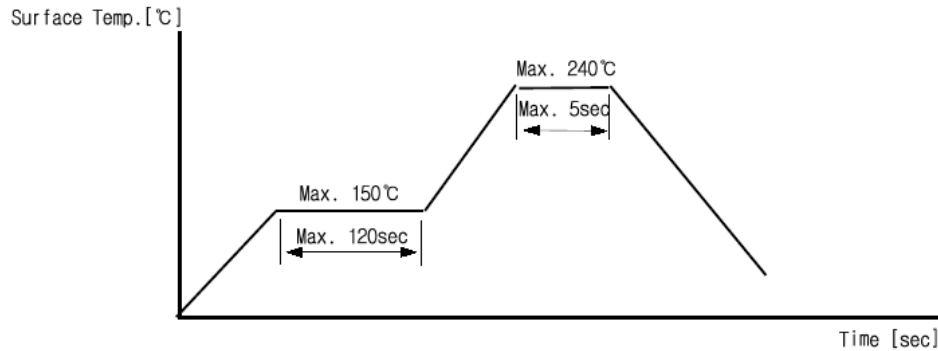

### Application Informatio

It is strongly recommended that an external bypass capacitor be connected (in close proximity to the Hall sensor) between the supply ( $V_{DD}$  Pin) and ground (GND Pin) of the device to reduce both external noise and noise generated by the chopper stabilization technique. As is shown in the following two figures, a  $0.1\mu\text{F}$  capacitor is typical.

For reverse voltage protection, it is recommended to connect a resistor or a diode in series with the  $V_{DD}$  pin. When using a resistor, three points are important:

- the resistor has to limit the reverse current to 50mA maximum ( $V_{CC} / R1 \leq 50\text{mA}$ )
- the resulting device supply voltage  $V_{DD}$  has to be higher than  $V_{DD}$  min ( $V_{DD} = V_{CC} - R1 * I_{DD}$ )
- the resistor has to withstand the power dissipated in reverse voltage condition ( $PD = V_{CC}^2 / R1$ )

When using a diode, a reverse current cannot flow and the voltage drop is almost constant ( $\approx 0.7\text{V}$ ).

Therefore, a  $100\Omega/0.25\text{W}$  resistor for 5V application and a diode for higher supply voltage are recommended.

When a weak power supply is used or when the device is intended to be used in noisy environment, it is recommended that the second figure is used.

The low-pass filter formed by  $R1$  and  $C1$  and the Zener diode  $Z1$  bypass the disturbances or voltage spikes occur-

**Typical Three-Wire Application Circuit**

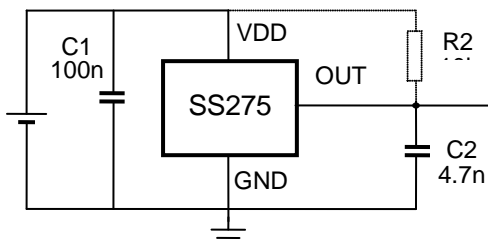

**Automotive and Severe Environment Protection Circuit**

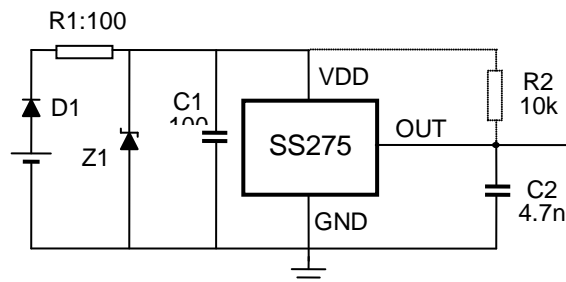

ring on the device supply voltage  $V_{DD}$ . The diode  $D1$  provides additional reverse voltage protection. Both solutions provide the required reverse voltage protection.

## Package Information

### Package SOT, 3-Pin SOT-23:

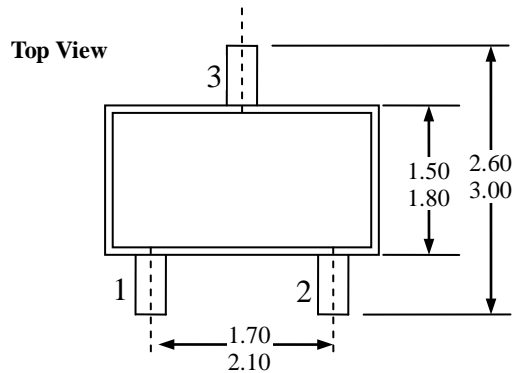

**Notes:**

- 1). PIN OUT: Pin 1  $V_{DD}$   
Pin 2 Output  
Pin 3 GND
- 2). All dimensions are in millimeters ;

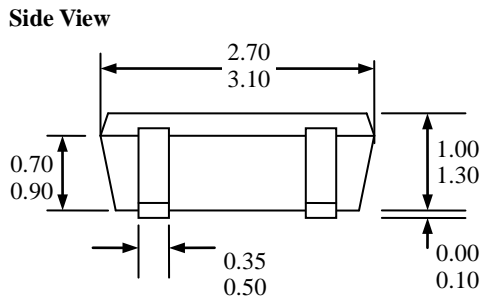

**End View**

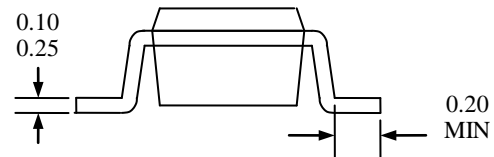

### SOT-23 Package Hall Location

**Bottom View of SOT-23 Package**

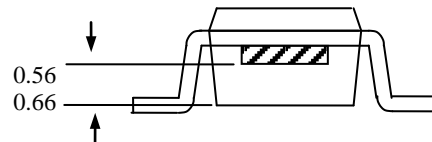
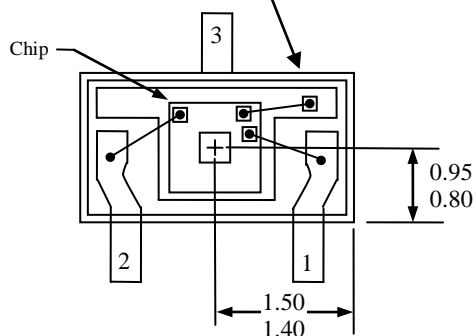

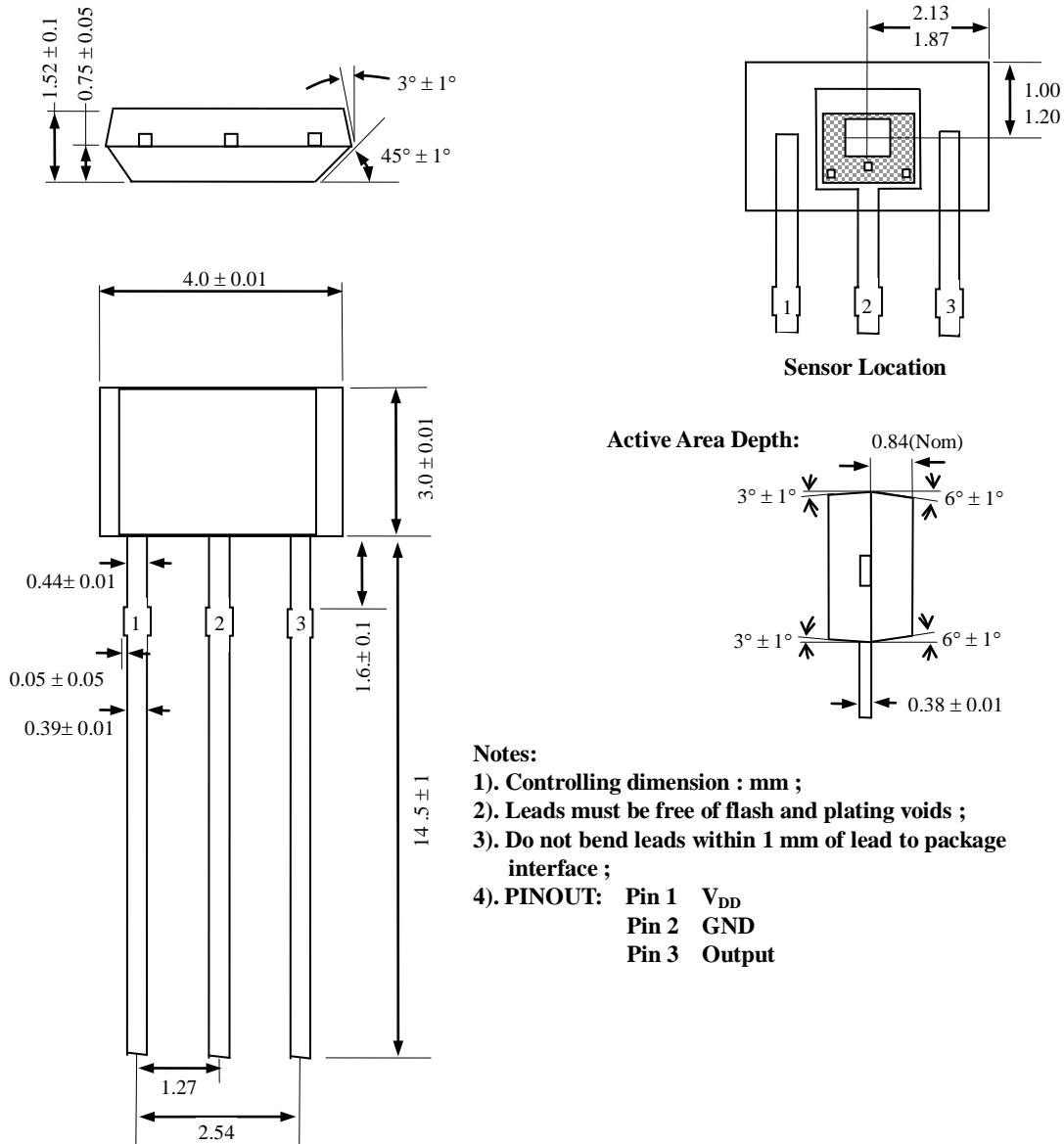
**Package UA, 3-Pin SIP:**

**Notes:**

- 1). Controlling dimension : mm ;
- 2). Leads must be free of flash and plating voids ;
- 3). Do not bend leads within 1 mm of lead to package interface ;
- 4). PINOUT: Pin 1  $V_{DD}$   
Pin 2 GND  
Pin 3 Output

**Ordering Information**

Part No.	Pb-free	Temperature Code	Package Code	Packing
SS275ESOT	YES	-40°C to 85°C	SOT-23	7-in. reel, 3000 pieces/ reel
SS275EUA	YES	-40°C to 85°C	TO-92	Bulk, 1000 pieces/ bag
SS275KSOT	YES	-40°C to 125°C	SOT-23	7-in. reel, 3000 pieces/ reel
SS275KUA	YES	-40°C to 125°C	TO-92	Bulk, 1000 pieces/ bag
SS275LSOT	YES	-40°C to 150°C	SOT-23	7-in. reel, 3000 pieces/ reel
SS275LUA	YES	-40°C to 150°C	TO-92	Bulk, 1000 pieces/ bag